

THE GLOBAL EXPERT  
IN **SOLID STATE**  
**POWER SWITCHING**  
TECHNOLOGY



■ Motor Controls



■ Power Supplies



■ Motor Generator Exciters



***crydom***<sup>®</sup>  
Power Modules

# crydom®

**C**rydom has a distinguished record of providing advanced, high quality products with timely delivery and competitive pricing. Your success in today's fast-paced global markets

hinges on working with suppliers who respond quickly and appropriately to your every need.

In addition to an extensive selection catalog off-the-shelf items, Crydom offers custom-designed power switching modules. Fact is we specialize in satisfying the most demanding environmental and performance requirements our customer can devise. Give us your specs, and watch us exceed your expectations!

At Crydom's custom-built **100,000 square foot manufacturing facility**, virtually everything is accomplished in-house to assure complete control over delivery, production and above all quality. With design, development, manufacturing and management personnel under one roof, we're geared for fast response to your requirements.

In **Design Engineering**, we focus on pushing performance, reliability and quality standards ever higher. Working under a conservative design and rating philosophy, Crydom's seasoned engineering team makes extensive use of CAD to optimize design of mechanical parts.

As a result of these efforts, Crydom has acquired an impressive list of patents in power switching technology, while continuing to create new circuit and technology-related inventions as part of our ongoing R & D programs.

Once the design is solidified, **Production Engineering** is responsible for the engineering control of the techniques used throughout manufacturing. This department works closely with our design engineering group, establishes assembly processes, and oversees a comprehensive on-premises machine shop which fabricates our assembly fixtures.

As the work progresses, **Material and Production Control** employ our advanced computer system, upgraded with our customized software to keep manufacturing operations humming. The Computer system employs integral MRP and MSP capabilities to generate detailed scheduling and planning information.

**Ceramic Hybrid Manufacturing** also is performed in-house. Crydom manufactures all metallized ceramic substrates used in our relays – a major factor in product performance and reliability, including direct bond copper substrates.

**Quality Assurance** conducts ongoing product reliability verification tests, gathering precise data on the quality of our power semiconductor vendors and the silicon chips they provide. Additional tests are performed to meet specific customer burn-in requirements.



[www.crydom.com](http://www.crydom.com)

Crydom tests are exhaustive, including 100% verification at final test. After units are fully assembled, they must pass a complete set of electrical tests, which are performed twice, once prior to encapsulation and then again afterward.

Because of our dedication to quality, Crydom was one of the first American companies to achieve full certification to the demanding standards of ISO 9001. In addition, most Crydom products are approved by UL, CSA, VDE, TUV and carry the CE Mark signifying conformance with the latest European directives.

Learn how an alliance with the world leader in solid state relays and power modules can pay off for you. For details, call your authorized Crydom distributor today.

## ***Power Modules***

Power Modules are power switching/control circuit elements integrated into convenient isolated-base packages, offering a broad spectrum of commonly used Diode, SCR, or SCR/Diode circuit configurations and ratings. Used in many types of equipment by a variety of industries, they utilize Crydom's renowned advanced thermal management techniques. The modules are mechanically and thermally optimized for ease of assembly, long life and reliable operation. Significant cost savings are realized from reductions in design, volume, mounting, connection, cooling, field maintenance, parts count, acquisition and inventory costs.

## ***Typical Applications***

AC motor drive front end	Medical Electronics
Appliances	Motor controls, AC
Battery charging	Motor controls, DC
Cathodic protection	Motor starters
Converters	Power Factor Correction
Conveyors	Power supplies
DC-choppers	Reverse polarity protection
Electroplating	Traction
Elevator controls	Transportation
Heater controls	UPS systems
HVAC controls	Welding
Inverters	

## ***Custom Designs***

Crydom's Sales and Technical Support teams work closely with you to define and develop customized solutions for your unique requirements. We can help you get that competitive edge necessary to be a leader in your industry. In-house capabilities include ceramic substrate production, SMT (surface mount technology) placement/insertion robotics assembly and elevated/low temperature monitored testing. All this interprets into fast-track design, prototype preparation, test, evaluate, adjust and finalize as necessary to achieve the specified performance criteria. Upon final customer approval we can quickly gear up to meet your production schedules in our ISO9001 certified manufacturing environment.





**L**  
**15-42.5Amp**  
 SCR/Diode Modules  
 Low Profile  
 Designed for PCB Connections

Circuit Modules provide ratings up to 42.5 amps in a low profile package designed for printed circuit board connections. Available in three standard bridge circuits and an AC switch version, all models have 2500 Vrms isolation and are UL recognized under file E72445. Mounting clip available, order part no. LMC-1.

### PART NUMBER IDENTIFICATION

Series	Current	Circuit Type	AC Line Voltage	Options
L	3 - 15 Amps	1 - 5	1 - 120 Vac	F - Free
	5 - 25 Amps	(See schematic diagrams)	2 - 240 Vac	Wheeling
	6 - 42.5 Amps*		3 - 280 Vac	Diode
			4 - 480 Vac	(Circuits 1, 2)

Example: L512F

\* 42.5 Amp Rating Not Available In Circuit 4

ELECTRICAL SPECIFICATIONS		L3	L5	L6
$I_D$	Maximum DC Output Current @ $T_c = 85^\circ\text{C}$	15A	25A	42.5A
$V_F$	Maximum Voltage Drop @ Amps Peak	2.2V@15A	1.65V@25A	1.6V@42.5A
$T_J$	Operating Junction Temperature Range	$-40^\circ\text{C}$ to $+125^\circ\text{C}$	$-40^\circ\text{C}$ to $+125^\circ\text{C}$	$-40^\circ\text{C}$ to $+125^\circ\text{C}$
di/dt	Critical Rate of Rise of On-State Current @ $T_J=125^\circ\text{C}$	100 A/ $\mu\text{s}$	100 A/ $\mu\text{s}$	100 A/ $\mu\text{s}$
dv/dt	Critical Rate of Rise of Off-State Voltage	500 V/ $\mu\text{s}$	500 V/ $\mu\text{s}$	500 V/ $\mu\text{s}$
$V_{RMS}$	AC Line Input Voltage (Repetitive Peak Reverse Voltage)	120 (400 $V_{RRM}$ )	120 (400 $V_{RRM}$ )	120 (400 $V_{RRM}$ )
		240 (600 $V_{RRM}$ )	240 (600 $V_{RRM}$ )	240 (600 $V_{RRM}$ )
		280 (800 $V_{RRM}$ )	280 (800 $V_{RRM}$ )	280 (800 $V_{RRM}$ )
		480 (1200 $V_{RRM}$ )	480 (1200 $V_{RRM}$ )	480 (1200 $V_{RRM}$ )
$I_{TSM}$	Maximum Non-Repetitive Surge Current ( $\frac{1}{2}$ Cycle, 60Hz)	225 A	300 A	600 A
$I^2T$	Maximum $I^2T$ for Fusing ( $t=8.3\text{ms}$ )	210A <sup>2</sup> sec	375A <sup>2</sup> sec	1500A <sup>2</sup> sec
$I_{GT}$	Maximum Required Gate Current to Trigger @ $25^\circ\text{C}$	60 mA	60 mA	80 mA
$V_{GT}$	Maximum Required Gate Voltage to Trigger @ $25^\circ\text{C}$	2.5V	2.5V	3.0V
$P_{G(AV)}$	Average Gate Power	0.5W	0.5W	0.5W
$V_{GM}$	Maximum Peak Gate Voltage (Reverse)	5.0V	5.0V	5.0V
$R_{\theta JC}$	Maximum Thermal Resistance Junction to Ceramic Base per Chip	1.25°C/W	0.9°C/W	0.7°C/W
$V_{ISOL}$	Isolation Voltage	2500 $V_{RMS}$	2500 $V_{RMS}$	2500 $V_{RMS}$

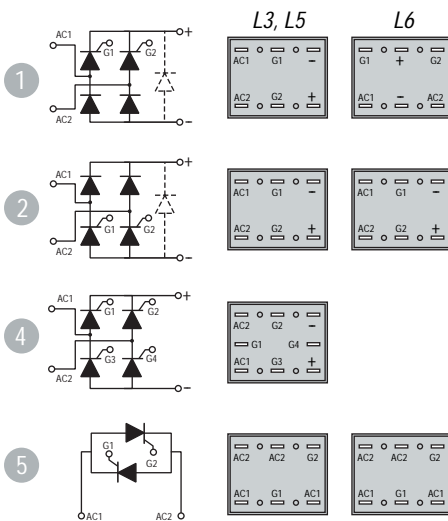

**F18**  
**25-105Amp**  
 Diode, SCR/Diode Modules  
 Standard Package and Circuits

Modules come in an industry standard package, offering nine circuits that can be used singly or as power control building blocks. All models feature highly efficient thermal management for greatly extended cycle life and are UL recognized under file E72445.

### PART NUMBER IDENTIFICATION

Series	Current	Circuit Type	AC Line Voltage
F18	27 - 25 Amps	(See schematic diagrams)	400 - 120 Vac
	42 - 40 Amps		600 - 240 Vac
	57 - 55 Amps	Example: SD	1000 - 380 Vac
	92 - 90 Amps		1200 - 480 Vac
	107 - 105 Amps		1400 - 530 Vac
			1600 - 600 Vac

Example: F1892SD1200

ELECTRICAL SPECIFICATIONS		27	42	57	92	107
$I_D$	Maximum DC Output Current @ $T_c = 85^\circ\text{C}$	25A	40A	55A	90A	105A
$V_F$	Maximum Voltage Drop @ Amps Peak	1.55V@75Apk	1.4V@120Apk	1.4V@165Apk	1.4V@270Apk	1.65V@300Apk
$T_J$	Operating Junction Temperature Range	$-40^\circ\text{C}$ to $+125^\circ\text{C}$				
di/dt	Critical Rate of Rise of On-State Current @ $T_J=125^\circ\text{C}$	100 A/ $\mu\text{s}$	100 A/ $\mu\text{s}$	100 A/ $\mu\text{s}$	100 A/ $\mu\text{s}$	100 A/ $\mu\text{s}$
dv/dt	Critical Rate of Rise of Off-State Voltage	500 V/ $\mu\text{s}$	500 V/ $\mu\text{s}$	500 V/ $\mu\text{s}$	500 V/ $\mu\text{s}$	500 V/ $\mu\text{s}$
$V_{RMS}$	Repetitive Peak Reverse Voltage (AC Line Input Voltage)	120 (400 $V_{RRM}$ )	120 (400 $V_{RRM}$ )	120 (400 $V_{RRM}$ )	120 (400 $V_{RRM}$ )	120 (400 $V_{RRM}$ )
		240 (600 $V_{RRM}$ )	240 (600 $V_{RRM}$ )	240 (600 $V_{RRM}$ )	240 (600 $V_{RRM}$ )	240 (600 $V_{RRM}$ )
		280 (800 $V_{RRM}$ )	280 (800 $V_{RRM}$ )	280 (800 $V_{RRM}$ )	280 (800 $V_{RRM}$ )	280 (800 $V_{RRM}$ )
		480 (1200 $V_{RRM}$ )	480 (1200 $V_{RRM}$ )	480 (1200 $V_{RRM}$ )	480 (1200 $V_{RRM}$ )	480 (1200 $V_{RRM}$ )
		530 (1400 $V_{RRM}$ )	530 (1400 $V_{RRM}$ )	530 (1400 $V_{RRM}$ )	530 (1400 $V_{RRM}$ )	530 (1400 $V_{RRM}$ )
		600 (1600 $V_{RRM}$ )	600 (1600 $V_{RRM}$ )	600 (1600 $V_{RRM}$ )	600 (1600 $V_{RRM}$ )	600 (1600 $V_{RRM}$ )
$I_{TSM}$	Maximum Non-Repetitive Surge Current ( $\frac{1}{2}$ Cycle, 60Hz)	400A	1000A	1500A	1950A	2250A
$I^2T$	Maximum $I^2T$ for Fusing ( $t=8.3\text{ms}$ )	670A <sup>2</sup> sec	4150A <sup>2</sup> sec	9350A <sup>2</sup> sec	15800A <sup>2</sup> sec	25000A <sup>2</sup> sec
$I_{GT}$	Maximum Required Gate Current to Trigger @ $25^\circ\text{C}$	150mA	150mA	150mA	150mA	150mA
$V_{GT}$	Maximum Required Gate Voltage to Trigger @ $25^\circ\text{C}$	3.0V	3.0V	3.0V	3.0V	3.0V
$P_{G(AV)}$	Average Gate Power	0.5W	0.5W	0.5W	0.5W	0.5W
$V_{GM}$	Maximum Peak Gate Voltage (Reverse)	5.0V	5.0V	5.0V	5.0V	5.0V
$R_{qJC}$	Maximum Thermal Resistance Junction to Ceramic Base per Module	0.4°C/W	0.28°C/W	0.25°C/W	0.14°C/W	0.135°C/W
$V_{ISOL}$	Isolation Voltage	2500 $V_{RMS}$	2500 $V_{RMS}$	2500 $V_{RMS}$	2500 $V_{RMS}$	2500 $V_{RMS}$

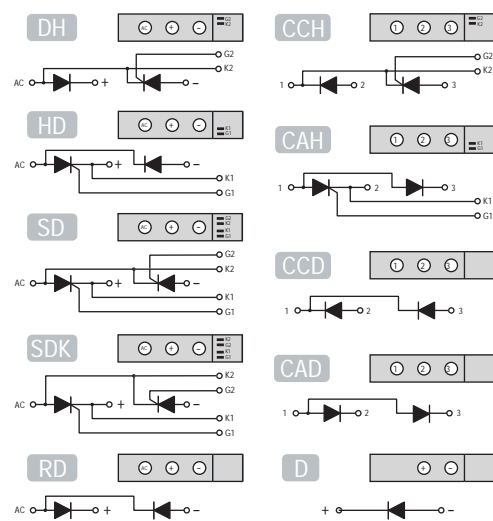



**B48-2T, B48-2**  
**35-50Amp**  
 Diode Modules  
 Single and Three Phase Circuits  
 Up to 1600 Volt Blocking Standard

Single- and three-phase diode circuits come in panel mount package that provides 2500 Vrms isolation from the terminals to the ceramic base. Available in ratings up to 1600 Volts, all models are UL recognized under file E72445.

**PART NUMBER IDENTIFICATION**

Series	Circuit Type	Voltage	Case Style
B48	1 - 5	B - 400 (120Vac)	-2T (Standard)
	(see schematic diagrams)	C - 600 (240Vac)	-2 With Isolation Barriers
		E - 1000 (380Vac)	
		F - 1200 (480Vac)	
		G - 1400 (530Vac)	
		H - 1600 (600Vac)	

Example: B483C-2T

**ELECTRICAL SPECIFICATIONS**

	SINGLE PHASE	THREE PHASE
$I_D$ Maximum DC Output Current ( $T_c = 85^\circ C$ )	35A	50A
$V_F$ Maximum Voltage Drop @ Amps Peak	1.25V @ 35A	1.35V @ 50A
$T_J$ Operating Junction Temperature Range	-40°C to +125°C	-40°C to +125°C
$V_{RRM}$ Repetitive Peak Reverse Voltage (Ac Line Input Voltage)	120 (400 $V_{RRM}$ )	120 (400 $V_{RRM}$ )
	240 (600 $V_{RRM}$ )	240 (600 $V_{RRM}$ )
	380 (1000 $V_{RRM}$ )	380 (1000 $V_{RRM}$ )
	480 (1200 $V_{RRM}$ )	480 (1200 $V_{RRM}$ )
	530 (1400 $V_{RRM}$ )	530 (1400 $V_{RRM}$ )
$I_{TSM}$ Maximum Non-Repetitive Surge Current ( $1/2$ Cycle, 60Hz)	600A	600A
$I^2T$ Maximum $I^2T$ for Fusing ( $t=8.3ms$ )	1500A <sup>2</sup> sec	1500A <sup>2</sup> sec
$R_{qJC}$ Maximum Thermal Resistance Junction to Ceramic Base per Chip	0.9°C/W	0.9°C/W
$V_{ISOL}$ Isolation Voltage	2500 $V_{RMS}$	2500 $V_{RMS}$

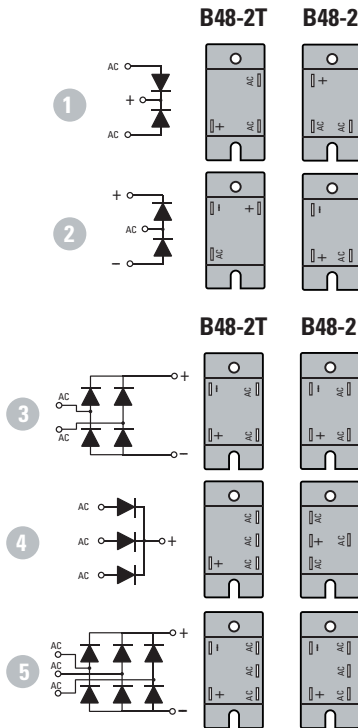

**B-2T, B-2**  
**25-42.5Amp**  
 SCR/Diode Modules  
 Eight Standard Circuits  
 AC or DC Variable Voltage Output to 15KW

Modules come in eight standard circuits and are designed to control AC and DC variable voltage output up to 15KW. The package comes with standard .250 quick-connect terminals. All modes have 2500 Vrms isolation and are UL recognized under file E72445. Optional isolation barriers are available.

**PART NUMBER IDENTIFICATION**

Series	Current	Circuit Type	AC Line Voltage	Options*	Case Style
B	5 - 25 Amps	1 - 8	1 - 120 Vac	F - Free Wheeling Diode (Circuits 1 & 2 Only)	-2T (Standard)
	6 - 42.5 Amps	(see schematic diagrams)	2 - 240 Vac		-2 With Isolation Barriers
			3 - 280 Vac	SE - External Suppressor	Barriers
			4 - 480 Vac	(-2T Only, Circuits 1-6 Only)	

Example: B512FSE-2T

**ELECTRICAL SPECIFICATIONS**

	B5	B6
$I_D$ Maximum DC Output Current ( $T_c = 85^\circ C$ )	25A	42.5A
$V_F$ Maximum Voltage Drop @ Amps Peak	1.65V @ 25A	1.6V @ 42.5A
$T_J$ Operating Junction Temperature Range	-40°C to +125°C	-40°C to +125°C
di/dt Critical Rate of Rise of On-State Current @ $T_J=125^\circ C$	100A/ $\mu s$	100A/ $\mu s$
dv/dt Critical Rate of Rise of Off-State Voltage	500V/ $\mu s$	500V/ $\mu s$
$V_{RRM}$ AC Line Input Voltage (Repetitive Peak Reverse Voltage)	120 (400 $V_{RRM}$ )	120 (400 $V_{RRM}$ )
	240 (600 $V_{RRM}$ )	240 (600 $V_{RRM}$ )
	280 (800 $V_{RRM}$ )	280 (800 $V_{RRM}$ )
$I_{TSM}$ Maximum Non-Repetitive Surge Current ( $1/2$ Cycle, 60Hz)	250A	600A
$I^2T$ Maximum $I^2T$ for Fusing ( $t=8.3ms$ )	260A <sup>2</sup> sec	1500A <sup>2</sup> sec
$I_{GT}$ Maximum Required Gate Current to Trigger @ 25°C	60mA	80mA
$V_{GT}$ Maximum Required Gate Voltage to Trigger @ 25°C	2.5V	3.0V
$G(AV)$ Average Gate Power	0.5W	0.5W
$P_{VGM}$ Maximum Peak Gate Voltage (Reverse)	5.0V	5.0V
$R_{qJC}$ Maximum Thermal Resistance Junction to Ceramic Base per Chip	0.9°C/W	0.7°C/W
$V_{ISOL}$ Isolation Voltage	2500 $V_{RMS}$	2500 $V_{RMS}$

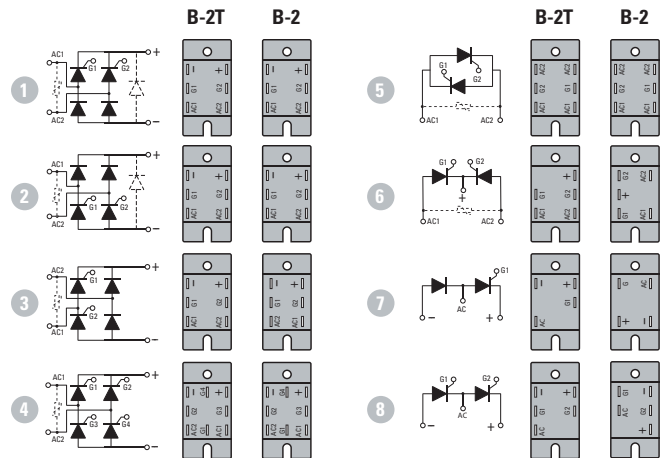

\*F option available in 1 and 2 circuits only, SE option available on -2T in circuits 1-6 only.



## M50 SCR/Diode Modules 50-100Amp

Over 40KW Output Capability

The M50 Series modules utilize highly efficient thermal management to provide high surge capability, long lifetime and reliable performance. Available in eight standard circuits, all models come in an industry standard package, provide 2500 Vrms from all terminals to the base plate and are UL recognized under file E72445.

### PART NUMBER IDENTIFICATION

Series	Current	Circuit Type	AC Line Voltage	Options*
M50	50 - 50 Amps	1 - 8	1 - 120 Vac	F - Free Wheeling Diode
	100 - 100 Amps	(see schematic diagrams)	2 - 240 Vac	V - External Suppressor
			3 - 280 Vac	
			4 - 380 Vac	
			5 - 480 Vac	

Example: M505012FV

### ELECTRICAL SPECIFICATIONS

	M5050	M50100
$I_D$ Maximum DC Output Current ( $T_c = 85^\circ\text{C}$ )	50A	100A
$V_F$ Maximum Voltage Drop @ Amps Peak	1.7V @ 50A	1.4V @ 100A
$T_J$ Operating Junction Temperature Range	$-40^\circ\text{C}$ to $+125^\circ\text{C}$	$-40^\circ\text{C}$ to $+125^\circ\text{C}$
$di/dt$ Critical Rate of Rise of On-State Current @ $T_J=125^\circ\text{C}$	100A/ $\mu\text{s}$	100A/ $\mu\text{s}$
$dv/dt$ Critical Rate of Rise of Off-State Voltage	500V/ $\mu\text{s}$	500V/ $\mu\text{s}$
$V_{RMS}$ AC Line Input Voltage (Repetitive Peak Reverse Voltage)	120 (400 $V_{RRM}$ )	120 (400 $V_{RRM}$ )
	240 (600 $V_{RRM}$ )	240 (600 $V_{RRM}$ )
	280 (800 $V_{RRM}$ )	280 (800 $V_{RRM}$ )
	380 (1000 $V_{RRM}$ )	380 (1000 $V_{RRM}$ )
	480 (1200 $V_{RRM}$ )	480 (1200 $V_{RRM}$ )
$I_{TSM}$ Maximum Non-Repetitive Surge Current ( $1/2$ Cycle, 60Hz)	600A	1500A
$I^2T$ Maximum $I^2T$ for Fusing ( $t=8.3\text{ms}$ )	1500 $\text{A}^2 \text{sec}$	9350 $\text{A}^2 \text{sec}$
$I_{GT}$ Maximum Required Gate Current to Trigger @ $25^\circ\text{C}$	150mA	150mA
$V_{GT}$ Maximum Required Gate Voltage to Trigger @ $25^\circ\text{C}$	3.0V	3.0V
$P_{G(AV)}$ Average Gate Power	0.5W	0.5W
$V_{GM}$ Maximum Peak Gate Voltage (Reverse)	5.0V	5.0V
$R_{qJC}$ Maximum Thermal Resistance Junction to Ceramic Base per Chip	0.7 $^\circ\text{C/W}$	0.36 $^\circ\text{C/W}$
$V_{ISOL}$ Isolation Voltage	2500 $V_{RMS}$	2500 $V_{RMS}$

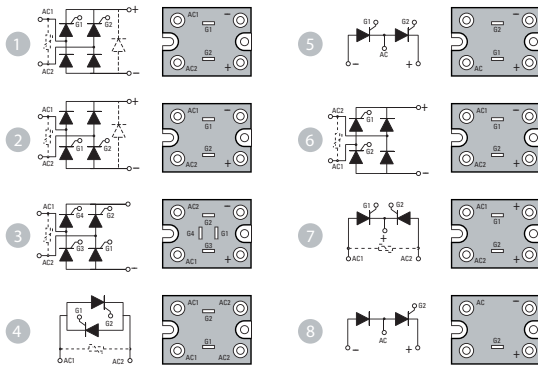

\*F option available in 1 and 2 circuits only, V option available in circuits 1,2,3,4,6 and 7 only.



## M50 Diode Modules 60-100Amp

High Surge Current Rectifier Circuits  
Up to 1600 Volt Blocking Standard

Single- and three-phase diode circuits incorporate highly efficient thermal management to provide high surge capability, extended life, and reliable performance. Available in five circuits, all models come in an industry standard package, provide 2500 Vrms from all terminals to the baseplate, and are UL recognized under file E72445.

### PART NUMBER IDENTIFICATION

Series	Current	Circuit Type	Voltage	
M50	60 - 60 Amps	(see schematic diagrams)	400 (120Vac)	1200 (480Vac)
	100 - 100 Amps		600 (240Vac)	1400 (530Vac)
		Example: TB	1000 (380Vac)	1600 (600Vac)

Example: M50100TB1200

### ELECTRICAL SPECIFICATIONS

	M5060	M50100
$I_D$ Maximum DC Output Current ( $T_c = 85^\circ\text{C}$ )	60A	100A
$V_F$ Maximum Voltage Drop @ Amps Peak	1.35V @ 60A	1.2V @ 100A
$T_J$ Operating Junction Temperature Range	$-40^\circ\text{C}$ to $+125^\circ\text{C}$	$-40^\circ\text{C}$ to $+125^\circ\text{C}$
$V_{RRM}$ (Repetitive Peak Reverse Voltage (AC Line))	120 (400 $V_{RRM}$ )	120 (400 $V_{RRM}$ )
	240 (600 $V_{RRM}$ )	240 (600 $V_{RRM}$ )
	380 (1000 $V_{RRM}$ )	380 (1000 $V_{RRM}$ )
	480 (1200 $V_{RRM}$ )	480 (1200 $V_{RRM}$ )
	530 (1400 $V_{RRM}$ )	530 (1400 $V_{RRM}$ )
$I_{TSM}$ Maximum Non-Repetitive Surge Current ( $1/2$ Cycle, 60Hz)	800A	1500A
$I^2T$ Maximum $I^2T$ for Fusing ( $t=8.3\text{ms}$ )	2650 $\text{A}^2 \text{sec}$	9350 $\text{A}^2 \text{sec}$
$R_{\theta JC}$ Maximum Thermal Resistance Junction to Ceramic Base per Chip	0.45 $^\circ\text{C/W}$	0.3 $^\circ\text{C/W}$
$V_{ISOL}$ Isolation Voltage	2500 $V_{RMS}$	2500 $V_{RMS}$

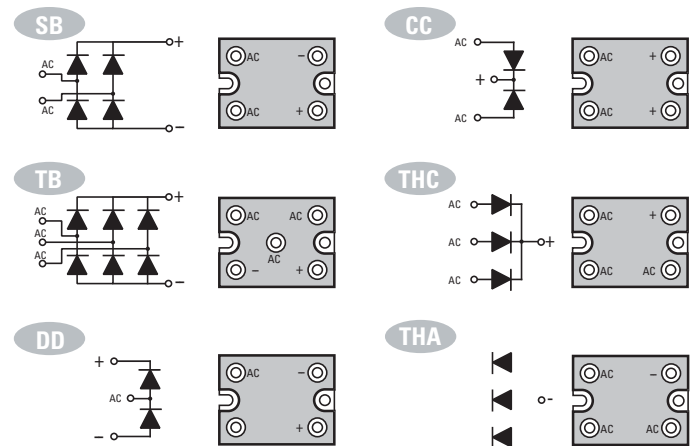



**EF**  
**50-170Amp**  
 Diode, SCR/Diode Modules  
 High Thermal Efficiency

These circuits provide complete power control in a single package, utilizing high thermal efficiency to assure long life and reliable performance. Twelve standard models provide 2500 Vrms isolation from all terminals to ceramic base and are UL recognized under file E72445.

### PART NUMBER IDENTIFICATION

Series	Current (Amps)	Circuit Type	Voltage	Options
EF	10 30 AC SW	(see schematic diagrams)	B - 400 (120 Vac)	F - Free Wheeling Diode (Circuits 1,2,16,19)
	D - 50 70 55	Example: 01	C - 500 (240 Vac)	
	E - 75 100 85		E - 1000 (380 Vac)	
	F - 100 135 110		F - 1200 (480 Vac)	
	G - 125 170 140		G - 1400 (530 Vac)	

Example: EFD02CF

### ELECTRICAL SPECIFICATIONS

	D	E	F	G
$I_D$ Maximum DC Output Current ( $T_c = 85^\circ\text{C}$ )	See Part Number Identification Above for Ratings of Single Phase, Three Phase and AC Switch Circuits			
$V_F$ Maximum Voltage Drop @ Amps Peak	1.7V @ 50A	1.85V @ 75A	1.4V @ 100A	1.55V @ 125A
$T_J$ Operating Junction Temperature Range	-40°C to +125°C		-40°C to +125°C	
di/dt Critical Rate of Rise of On-State Current @ $T_J=125^\circ\text{C}$	100A/ $\mu\text{s}$		100A/ $\mu\text{s}$	
dv/dt Critical Rate of Rise of Off-State Voltage	500V/ $\mu\text{s}$		500V/ $\mu\text{s}$	
$V_{RRM}$ Repetitive Peak Reverse Voltage (AC Line)	120 (400 $V_{RRM}$ ) 240 (600 $V_{RRM}$ ) 380 (1000 $V_{RRM}$ ) 480 (1200 $V_{RRM}$ ) 530 (1400 $V_{RRM}$ )		120 (400 $V_{RRM}$ ) 240 (600 $V_{RRM}$ ) 380 (1000 $V_{RRM}$ ) 480 (1200 $V_{RRM}$ ) 530 (1400 $V_{RRM}$ )	
$I_{TSM}$ Maximum Non-Repetitive Surge Current ( $1/2$ Cycle, 60Hz)	400A	600A	1500A	1950A
$I^2T$ Maximum $I^2T$ for Fusing ( $t=8.3\text{ms}$ )	670A <sup>2</sup> sec	1500A <sup>2</sup> sec	9340A <sup>2</sup> sec	15800A <sup>2</sup> sec
$I_{GT}$ Maximum Required Gate Current to Trigger @ 25°C	60mA	80mA	150mA	150mA
$V_{GT}$ Maximum Required Gate Voltage to Trigger @ 25°C	2.5V	3.0V	3.0V	3.0V
$P_{G(AV)}$ Average Gate Power	0.5W	0.5W	0.5W	0.5W
$V_{GM}$ Maximum Peak Gate Voltage (Reverse)	5.0V	5.0V	5.0V	5.0V
$R_{\theta JC}$ Maximum Thermal Resistance Junction to Ceramic Base per Chip	0.8°C/W	0.7°C/W	0.36°C/W	0.3°C/W
$V_{ISOL}$ Isolation Voltage	2500 $V_{RMS}$	2500 $V_{RMS}$	2500 $V_{RMS}$	2500 $V_{RMS}$

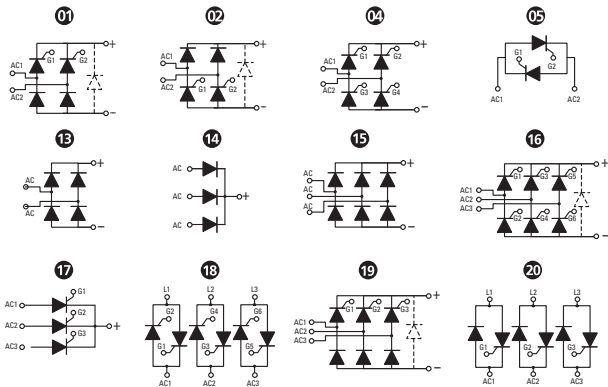

## Questions?

**Americas Tech Support:**  
 e-mail: [support@crydom.com](mailto:support@crydom.com)

**EMEA Tech Support:**  
 e-mail: [tech-europe@crydom.com](mailto:tech-europe@crydom.com)

## Americas Customer Service Center:

> +1 (877) 502-5500  
 > 7am-5pm (PST), Monday-Friday  
 > e-mail: [sales@crydom.com](mailto:sales@crydom.com)

## EMEA Customer Service Center:

> + 44 (0) 1202-606030  
 > 8:30am-4:45pm (GMT), Monday-Thursday  
 > 8:30am-3:15pm (GMT), Friday  
 > e-mail: [sales-europe@crydom.com](mailto:sales-europe@crydom.com)

**crydom**  
Across the Globe



Crydom is an operation of Custom Sensors & Technologies (CST), a business unit of Schneider Electric.

 **AMERICAS**

 **USA/CANADA**

**Crydom Inc**  
2320 Paseo de las Americas,  
Suite 201  
San Diego CA 92154

**Sales Support**  
Tel.: +1 (877) 502 5500  
Fax: +1 (619) 710 8540  
sales@crydom.com

**Tech Support**  
Tel.: +1 (877) 702 7700  
support@crydom.com

 **MEXICO**

**Automatismo Crouzet S.A. de C.V.**

Calzada Zavaleta 2505 - C  
Col Sta Cruz Buenavista  
C.P. 72150 - Puebla  
MEXICO  
Tel.: +52 (222) 409 7000  
Fax: +52 (222) 409 7810  
01 800 087 6333

 **SOUTHERN AND CENTRAL AMERICAN COUNTRIES**

**CST Latinoamerica**  
Alameda Rio Negro, 1.084-cj.A31  
Centro Empresarial de Alphaville  
CEP: 06454-000  
Barueri - SP  
BRASIL  
Tel.: +55 (11) 4191 9797  
Fax: +55 (11) 4191 9136  
info@cst-latinoamerica.com

 **EUROPE MIDDLE EAST AFRICA**

 **UNITED KINGDOM**

**Crydom SSR Ltd**  
Arena Business Centre  
Holyrood, Close  
Poole, Dorset BH17 7FJ

**Sales Support**  
Tel.: +44 (0) 1202 606030  
Fax: +44 (0) 1202 606035  
sales-europe@crydom.com

**Tech Support**  
tech-europe@crydom.com

 **AUSTRIA**

Tel.: +49 (0) 180 3000 506  
Fax: +49 (0) 180 3205 227  
vertrieb@crydom.com

 **BELGIUM**

Tel.: +32 (0) 2 460 4413  
Fax: +32 (0) 2 461 2614  
sales-europe@crydom.com

 **FRANCE**

 **0 810 123 963**  
PRE APPEL LOCAL  
 **0 810 057 605**  
PRE APPEL LOCAL  
sales-europe@crydom.com

 **GERMANY**

Tel.: +49 (0) 180 3000 506  
Fax: +49 (0) 180 3205 227  
vertrieb@crydom.com

 **ITALY**

Tel.: +39 (0) 2 665 99 260  
Fax: +39 (0) 2 665 99 268  
sales-europe@crydom.com

 **THE NETHERLANDS**

Tel.: +31 (0) 71 582 0068  
Fax: +31 (0) 71 542 1648  
sales-europe@crydom.com

 **SPAIN**

Tel.: +34 902 876 217  
Fax: +34 902 876 219  
sales-europe@crydom.com

 **PORTUGAL**

Tel.: +44 (0) 1202 606034  
Fax: +44 (0) 1202 606035  
sales-europe@crydom.com

 **SWITZERLAND**

Tel.: +49 (0) 180 3000 506  
Fax: +49 (0) 180 3205 227  
vertrieb@crydom.com

 **MIDDLE EAST, AFRICA AND OTHER EUROPEAN COUNTRIES**

Tel.: +44 (0) 1202 606030  
Fax: +44 (0) 1202 606035  
sales-europe@crydom.com

 **ASIA PACIFIC**

**CHINA & HONG KONG Custom Sensors & Technologies (Shanghai) Ltd.**

2 Floor, Innovation Building,  
No.1009, Yi Shan Road,  
Shanghai, 200233  
Tel.: +86 (21) 2401 7766  
Fax: +86 (21) 6249 0701  
sales-cn@crydom.com

**TAIWAN**

**Custom Sensors & Technologies**

3F, No. 39, Ji-Hu Road  
Nei-Hu Dist.  
Taipei 114, Taiwan  
Tel.: +886 2 8751 6388  
Fax: +886 2 2657 8725  
sales-tw@crydom.com

 **SOUTH KOREA**

**Custom Sensors & Technologies**

5F, Jeil Bldg.,  
94-46 Youngdeungpo-dong 7-ga  
Youngdeungpo-gu,  
Seoul, 150-037  
South Korea  
Tel.: +82 2 2629 8312  
sales-tw@crydom.com

 **INDIA**

**CST Sensors India Pvt Ltd**

Unit 1301 and 1302 Prestige  
Meridian II  
30 M.G.Road,  
Bangalore - 560001  
INDIA  
Tel.: +91 (80) 4113 2204/05  
Fax: +91 (80) 4113 2206  
india@cstsensors.com

 **OTHER ASIAN AND PACIFIC COUNTRIES**

**Custom Sensors & Technologies**

3F, No. 39, Ji-Hu Road  
Nei-Hu Dist.  
Taipei 114, Taiwan  
Tel.: +886 2 8751 6388  
Fax: +886 2 2657 8725  
sales-tw@crydom.com

CAT/CR/PM/EN

Distributed by :